

G 3000 i

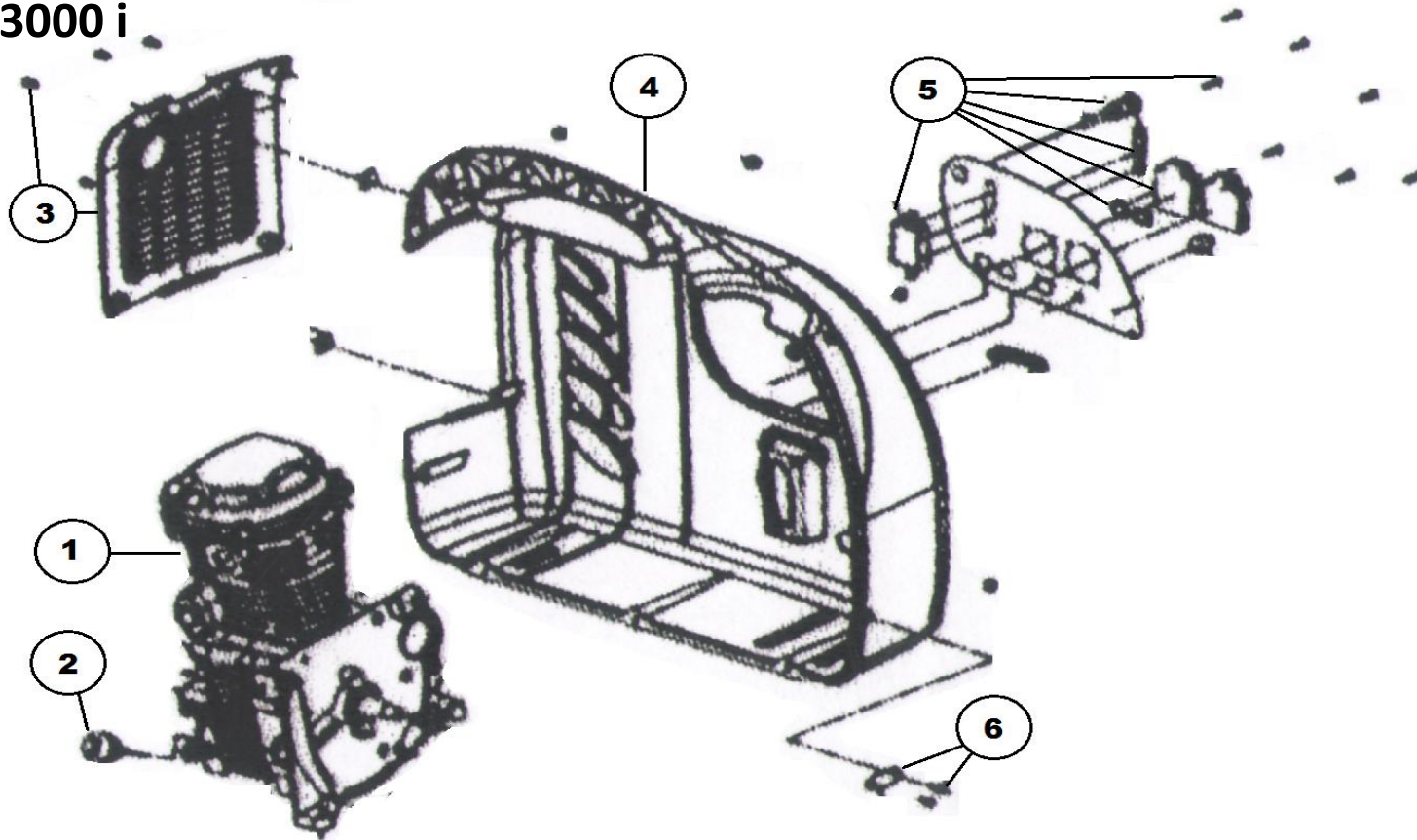

G 3000 i											
No.	P/N	Description	Qty	No.	P/N	Description	Qty	No.	P/N	Description	Qty
1	68-645	Long Block Assy.	1	3	68-603	Muffler Cover Kit	1	5	68-649	Panel Assy.	1
2	68-602	Oil Dip Stick	1	4	68-604	Left Casing Kit	1	6	68-606	Case Connecting Plate kit	1

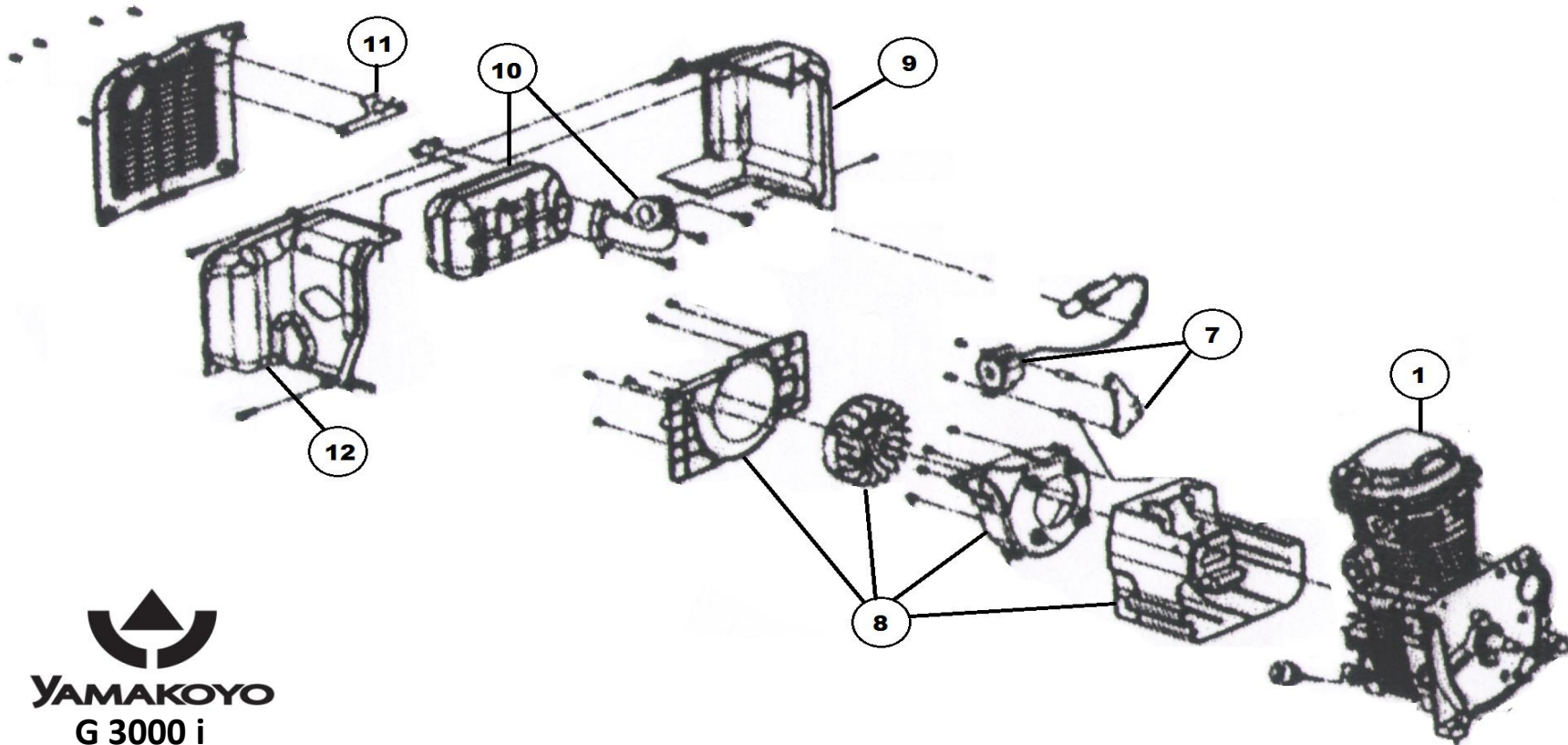

YAMAKOYO
G 3000 i

G 3000 i

No.	P/N	Description	Qty	No.	P/N	Description	Qty	No.	P/N	Description	Qty
1	68-645	Long Block Assy.	1	9	68-609	Right Engine Wind Cover	1	12	68-612	Left Engine Wind Cover	1
7	68-607	Ignition Coil Kit	1	10	68-610	Muffler kit	1	13	68-640	Spark Plug	1
8	68-608	Fly Wheel Kit	1	11	68-611	Rear Cover Junction Plate	1				

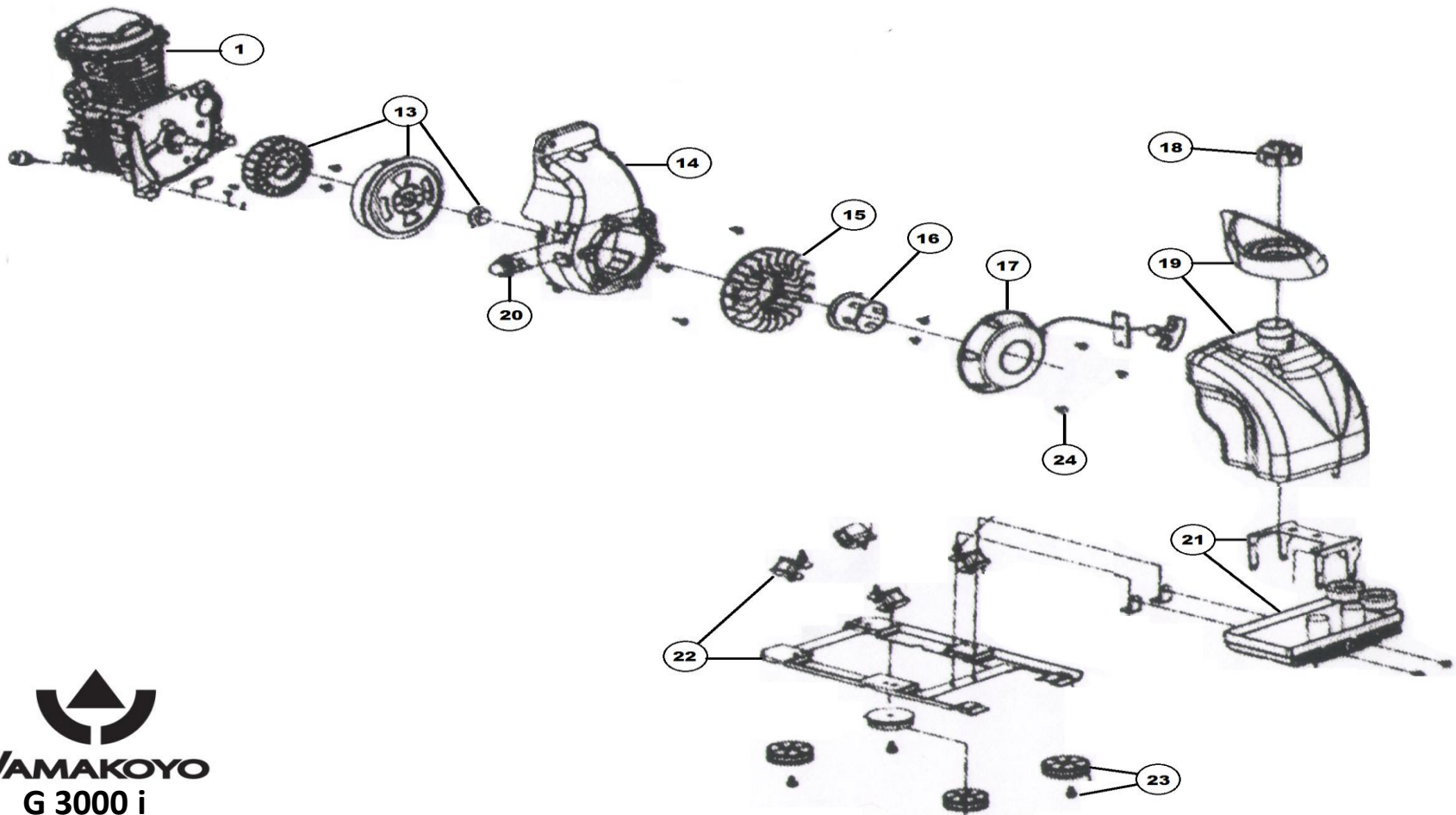

G 3000 i

No.	P/N	Description	Qty	No.	P/N	Description	Qty	No.	P/N	Description	Qty
1	68-645	Long Block Assy.	1	16	68-616	Starter Cup	1	20	68-620	Primer Bulb Kit	1
13	68-641	Rotor & Stator Kit	1	17	68-617	Recoil Stater Assy.	1	21	68-648	Inverter Module	1
14	68-614	Motor Wind Cover	1	18	68-618	Fuel Tank Cap	1	22	68-622	Engine Mounting Kit	1
15	68-615	Fly Wheel Fan	1	19	68-619	Fuel Tank Kit	1	23	68-623	Inverter Shock Kit	1

Technical Support:
 1-866-852-6872
 www.kbnusa.com

©Yamakoyo Machinery Co., Ltd.
 Rev. 0411

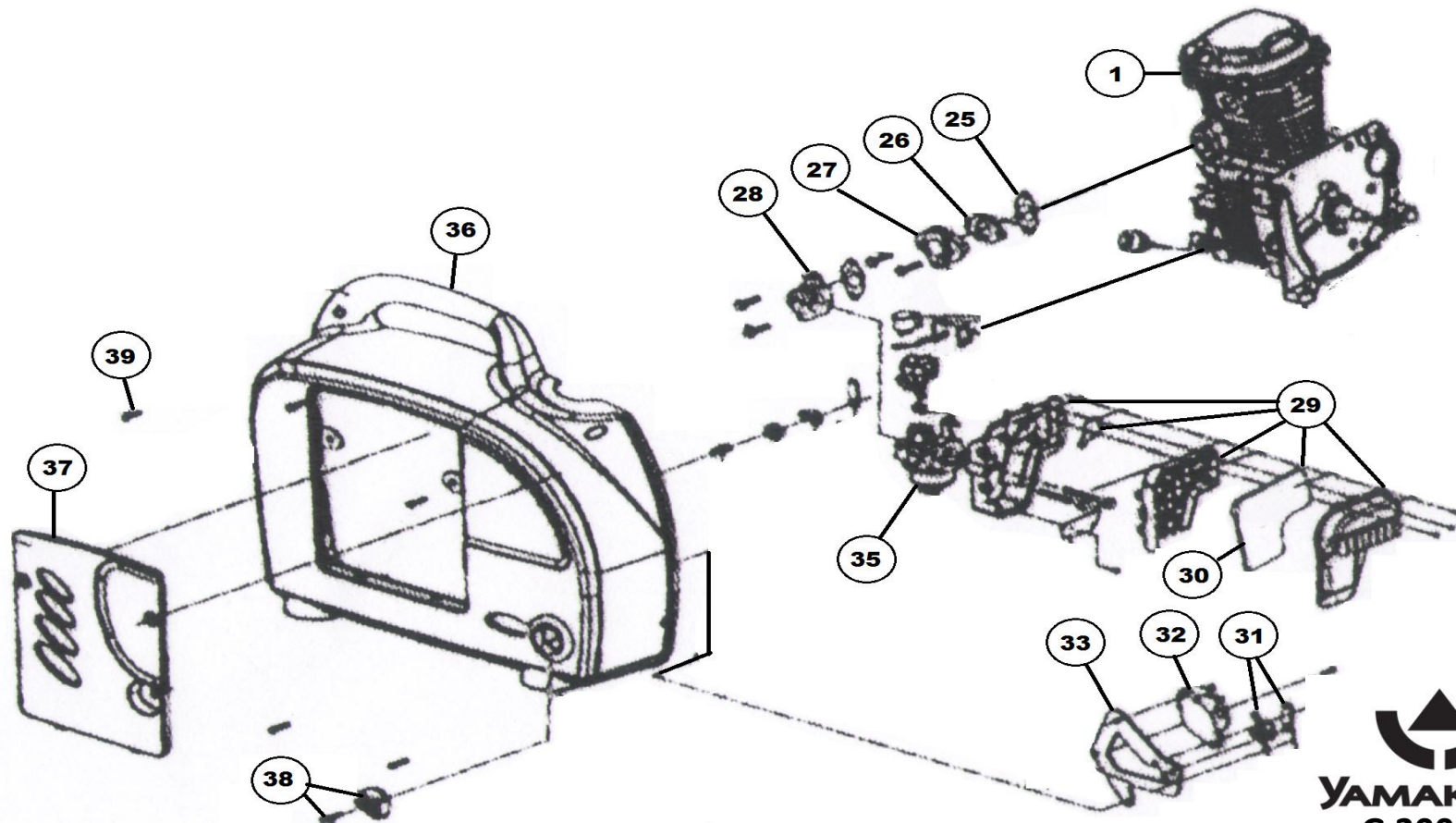

G 3000 i											
No.	P/N	Description	Qty	No.	P/N	Description	Qty	No.	P/N	Description	Qty
1	68-645	Long Block Assy.	1	29	68-629	Air Filtration Kit	1	35	68-642	Carburetor Assy.	1
25	68-625	Carburetor Gasket 1	1	30	68-630	Air Filter	1	36	68-636	Inverter Right Cover Kit	1
26	68-626	Carburetor Gasket 2	1	31	68-631	Fuel Valve Kit	1	37	68-637	Access Panel	1
27	68-627	Carb. Connecting Flange	1	32	68-632	Vacuum Pump Kit	1	38	68-638	Fuel Valve Knob	1
28	68-628	Carb. Bend Joint	1	33	68-633	Vacuum Pump Holder	1	39	68-639	M5 Screw	1

Technical Support:
1-866-852-6872
www.kbnusa.com

©Yamakoyo Machinery Co., Ltd.
Rev. 0411